



**ACESSÓRIOS
DE MOTOENXADA**
*Recambios de Motoazada
Mini Tiller Spare Parts*

7021

EAN 5604547060951

ABRE REGOS regulável - Barra 40x10mm
Largura de trabalho regulável
Adaptável: LIKE BIG/ ML500/ ML750/ ML1000



7097

EAN 5604547036628

ABRE REGOS N.º 2 Regulável Motoenxada KONTA WM500/ K500
Barra 30 x 12mm
Furação 8mm
Largura de trabalho regulável



7005

EAN 5604547020849

ABRE REGOS N.º 2 Regulável - Barra 30 x 10mm
Largura de trabalho regulável
Furação 12mm



7015

EAN 5604547001930

ABRE REGOS N.º 2 Regulável - Barra 35 x 12mm
Largura de trabalho regulável
Furação 12mm
Adaptável: LIKE BIG/ ML500/ ML750/ ML1000



*As fotos podem não corresponder em rigor ao modelo referenciado.
Peças não originais das marcas referidas.*

7012

EAN 5604547016521

ABRE REGOS N.º 2 - Barra 50 x 12mm
Largura de trabalho regulável
Furação 12mm



5300

EAN 5604547001947

ABRE REGOS 2 LINHAS
Largura e Profundidade de trabalho regulável

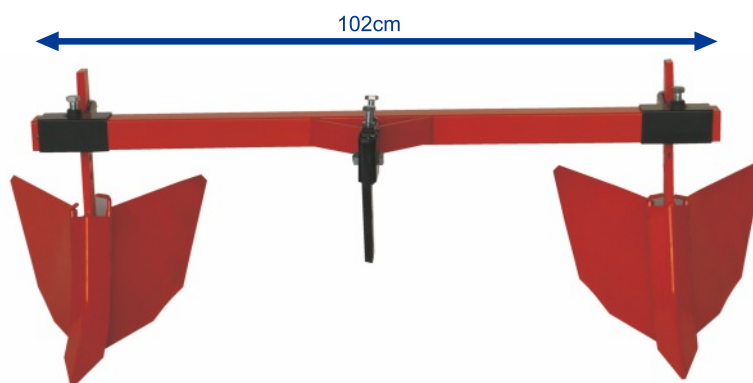

7023

EAN 5604547017085

ARRANCADOR DE BATATAS Barra 30 x 10mm
Profundidade de trabalho regulável
Furação 12mm



7022

EAN 5604547016774

ARRANCADOR DE BATATAS Barra 35 x 12mm
Profundidade de trabalho regulável
Furação 12mm
Adaptável: LIKE BIG/ ML500/ ML750/ ML1000



*As fotos podem não corresponder em rigor ao modelo referenciado.
Peças não originais das marcas referidas.*

5390

EAN 5604547002050

SACHADOR + AMONTOADOR AGRICOLA
Largura e Profundidade de trabalho regulável



1+1



5315

EAN 5604547030152

CHARRUA giratória tipo nacional
Profundidade de trabalho regulável

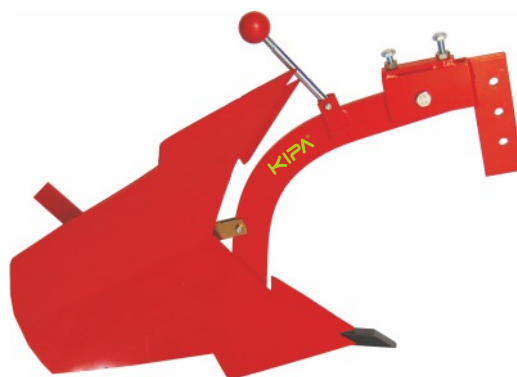

5355

EAN 5604547052444

CHARRUA descentrável lisa KIPA
Profundidade de trabalho regulável,
engate incluído 73mm altura x 16mm furo
Adaptável: LIKE ML500/ ML750
HONDA/ KUBOTA



As fotos podem não corresponder em rigor ao modelo referenciado.
Peças não originais das marcas referidas.

7522

EAN 5604547061644

CHARRUA DESCENTRÁVEL LISA GRANDE

Profundidade de trabalho regulável



4274

EAN 5604547066045

CHARRUA descentrável varetas

Profundidade de trabalho regulável



5305

EAN 5604547027237

ABRE REGOS - Aplicável à charrua

Adaptável a charruas ref. 4274 e ref. 7522

Espessura do veio: 20mm

Largura de trabalho regulável



5307

EAN 5604547027244

ARRANCADOR DE BATATAS - Aplicável à charrua

Adaptável a charruas ref. 4274 e ref. 7522

Espessura do veio: 20mm



6380

EAN 5604547004344

ENGATE LIKE BIG / BOSS / FAMOSA

adaptável a:

- Charrua
- Abre Regos 2 linhas
- Sachador
- Semeador

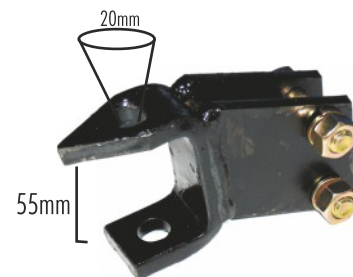
**6370**

EAN 5604547004337

ENGATE HONDA / KUBOTA / KONTA / LIKE 73 x 16mm

adaptável a:

- Charrua
- Abre Regos 2 linhas
- Sachador
- Semeador

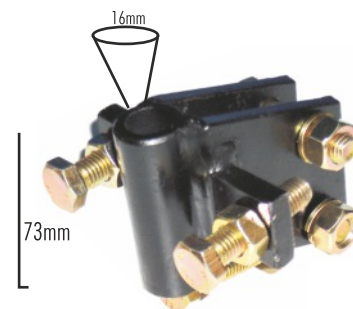
**6375**

EAN 5604547027251

ENGATE YENMAR / HONDA / KUBOTA 93 x 16mm

adaptável a:

- Charrua
- Abre Regos 2 linhas
- Sachador
- Semeador

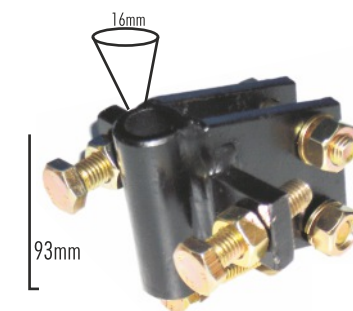
**22K8**

EAN 5604547004061

PESO DE 11 Kg Jante 8 (2 = 22Kg)
s/ parafusos de aperto**40K10**

EAN 5604547004054

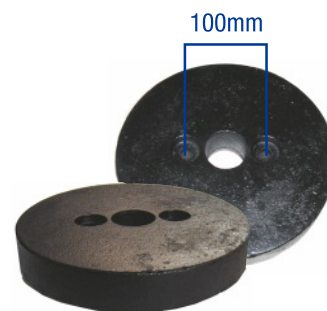
PESO DE 20 Kg Jante 8 / Jante 10 (2 = 40Kg)
s/ parafusos de aperto**EIXOS FURAÇÃO UNIVERSAL****5501**

EAN 5604547029811

EIXOS FIXOS 25mm (redondo) com 80mm comprimento (2)

5502

EAN 5604547029828

EIXOS FIXOS 23mm (hexagonal) com 80mm comprimento (2)

5503

EAN 5604547029835

EIXOS FIXOS 27mm (hexagonal) com 80mm comprimento (2)

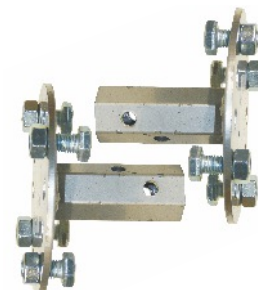
**3943**

EAN 5604547070035

DESBLOQUEIO 23mm (hexagonal) (2)
Furação Balila - JAPONESA/CHINESA

As fotos podem não corresponder em rigor ao modelo referenciado.
Peças não originais das marcas referidas.

5495

EAN 5604547019942

DESBLOQUEIO 25mm (Ø redondo) (2)
Furação Universal

5480

EAN 5604547002326

DESBLOQUEIO 23mm (hexagonal) (2)
Furação Universal

5431

EAN 5604547056329

DESBLOQUEIO 27mm (hexagonal) (2)
Furação Universal

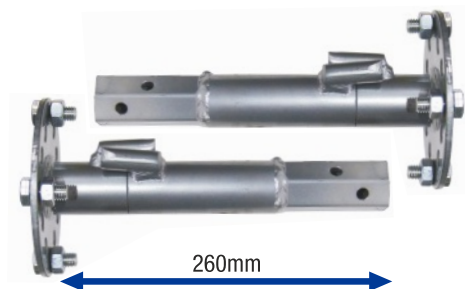

5492

EAN 5604547019935

DESBLOQUEIO descentrável 23mm (hexagonal) (2)
Furação Universal
Largura de trabalho mínima: 170mm
Largura de trabalho máxima: 300mm



6535

EAN 5604547027558

LANÇA para motoenxada PUBERT
Comprimento da lança: 245mm

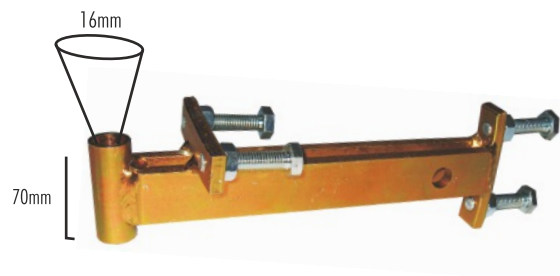

6540

EAN 5604547004832

LANÇA para motoenxada LIKE modelos BIG / BOSS / FAMOSA
Comprimento da lança: 338mm



6537

EAN 5604547029309

LANÇA para motoenxada HONDA / KUBOTA
KONTA / LIKE
Comprimento da lança: 285mm

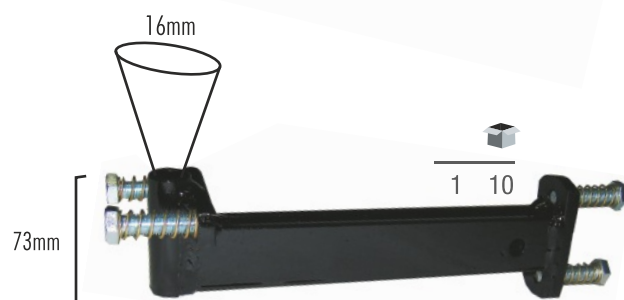

9359

EAN 5604547044593

LANÇA descentrável HONDA / KONTA
KUBOTA / LIKE
Comprimento da lança: 450mm

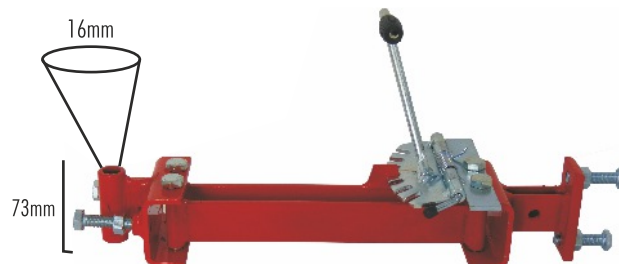

As fotos podem não corresponder em rigor ao modelo referenciado.
Peças não originais das marcas referidas.

7028

EAN 5604547036161

SEMEADOR DE DISCO PARA MOTOENXADA

Inclui: 3 discos (10, 13 e 15mm)



7594

EAN 5604547062597

SEMEADOR + ADUBADOR PARA MOTOENXADA

Inclui: 3 discos (10, 13 e 15mm)



7595

EAN 5604547062603

SEMEADOR DE BATATAS PARA MOTOENXADA



8110

EAN 5604547019393

TUBO HEXAGONAL 22mmx30mm

8108

EAN 5604547002876

TUBO HEXAGONAL 23mmx32mm

9639

EAN 5604547054363

TUBO HEXAGONAL 26mmx35mm

8112

EAN 5604547019409

TUBO HEXAGONAL 27mmx35mm

9640

EAN 5604547054370

TUBO HEXAGONAL 28mmx36mm

8115

EAN 5604547019416

TUBO HEXAGONAL 30mmx40mm

9638

EAN 5604547054356

TUBO HEXAGONAL 32mmx40mm

 Metro

 Metro

 Metro

 Metro

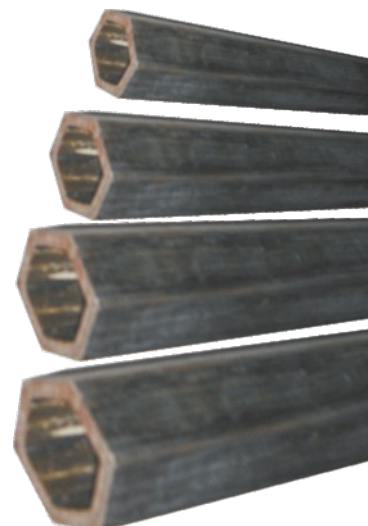

As fotos podem não corresponder em rigor ao modelo referenciado.
Peças não originais das marcas referidas.



8412

EAN 5604547024083

FRESA KIPA 25mm (Ø redondo) (2)

Distância da extremidade até ao centro do furo: 20mm

Diâmetro do furo: 10mm

APLICÁVEL ÀS MOTOENXADAS DE CORREIAS FRANCESAS E ITALIANAS

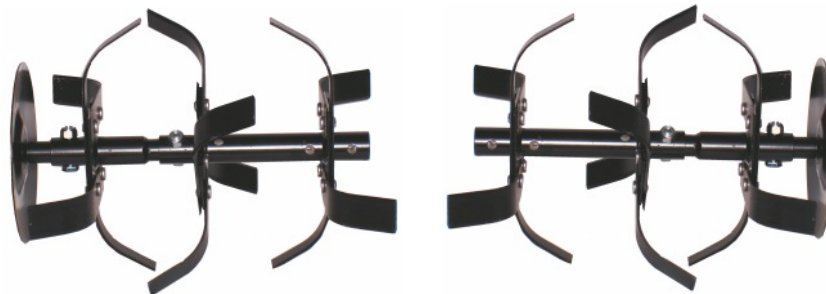

4000

EAN 5604547058200

FRESA LIKE 23mm (hexagonal) (2)

Distância da extremidade até ao centro do furo: 55mm

Diâmetro do furo: 8mm / Diâmetro Guarda Pó: 65mm

APLICÁVEL À MOTOENXADA ML500/ML750

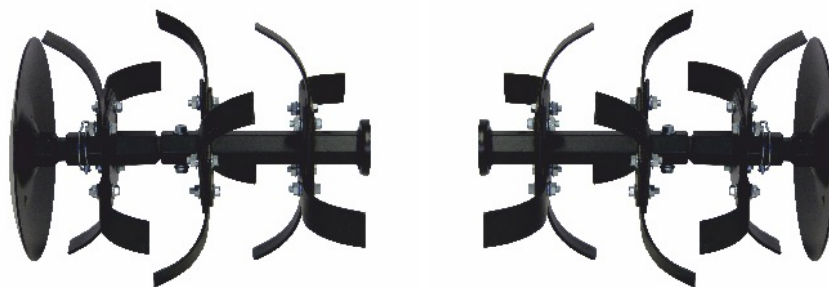

4007

EAN 5604547068865

FRESA LIKE 23mm (hexagonal) (2)

Distância da extremidade até ao centro do furo: 55mm

Diâmetro do furo: 8mm / Sem guarda pó

APLICÁVEL À MOTOENXADA LIKE ML 1000



6478

EAN 5604547018839

FRESA LIKE 27mm (hexagonal) (2)

Distância da extremidade até ao centro do furo: 50mm

Diâmetro do furo: 8mm / Aplicável à BOSS/BIG





7160

FACA MOTOENXADA SAFARY / GIRA / DAKAR / KONTA WM500

EAN 5604547002593

Kit de 24; furo 8mm

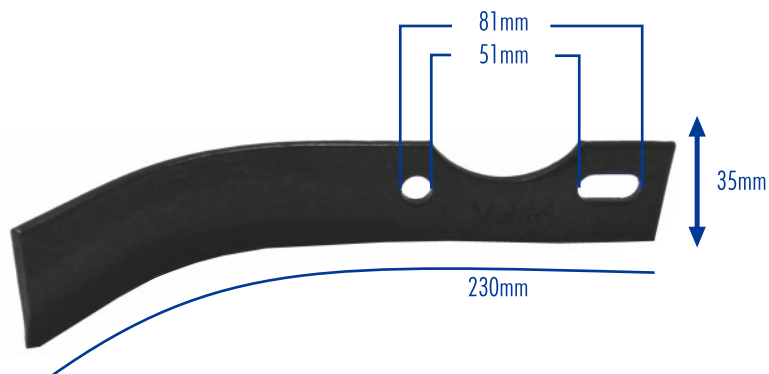

7168

FACA MOTOENXADA HELICOIDAL SAFARY / GIRA / DAKAR / KONTA WM500

EAN 5604547032484

Kit de 24; furo 8mm

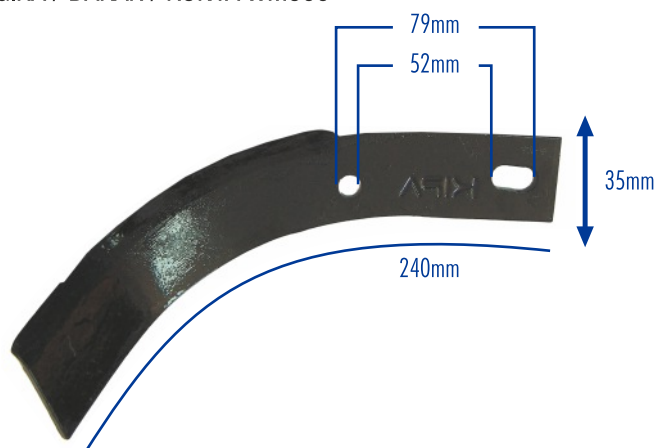

7165

FACA MOTOENXADA BOSS - BIG;

EAN 5604547002609

Kit de 24; furo 10mm

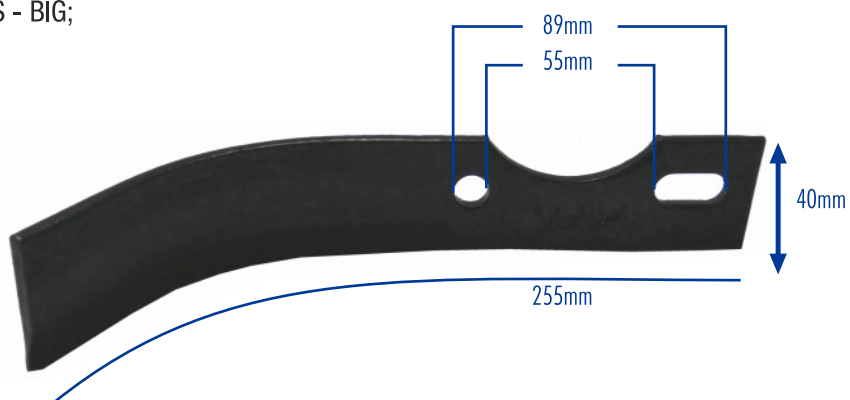

7170

FACA MOTOENXADA FAMOSA / BIG;

EAN 5604547002616

Kit de 24; furo 10mm





9480

FACA MOTOENXADA FORT MINI TIGRE

EAN 5604547048416

Kit de 24; furo 8mm

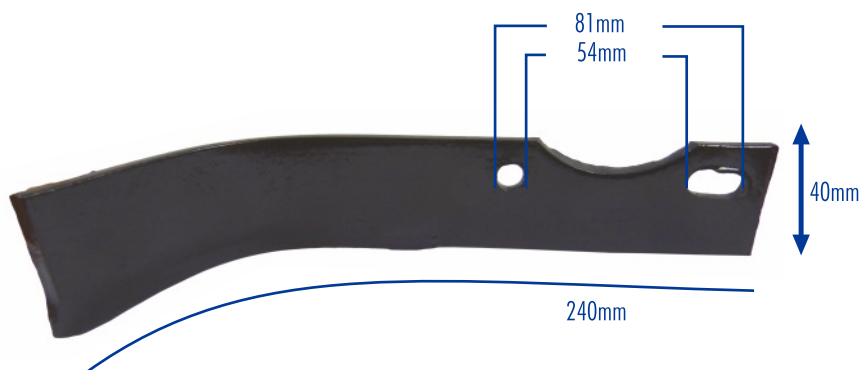

9476

FACA MOTOENXADA HONDA furação larga

EAN 5604547048379

Kit de 24; furo 8mm

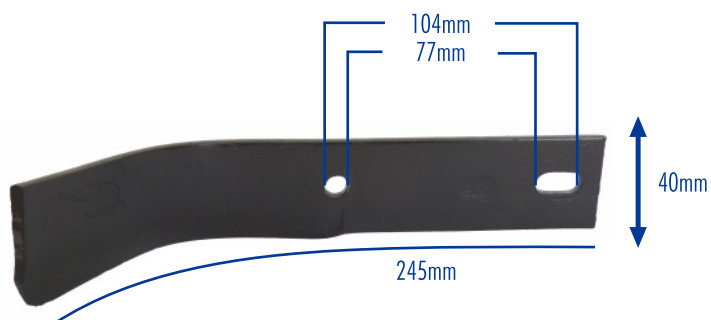

9477

FACA MOTOENXADA FORT MINI TIGROTO

EAN 5604547048386

Kit de 24; furo 10mm

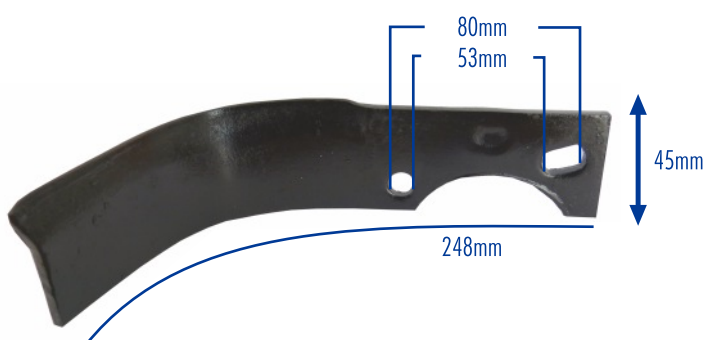

9481

FACA MOTOCULTIVADOR GOLDONI FORT

EAN 5604547048423

Kit de 20; furo 10mm

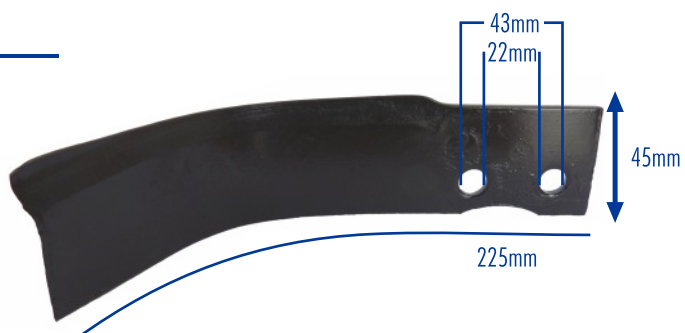



9483

FACA MOTOCULTIVADOR GRILO/GOLDONI

EAN 5604547048447

Kit de 24; furo 10mm

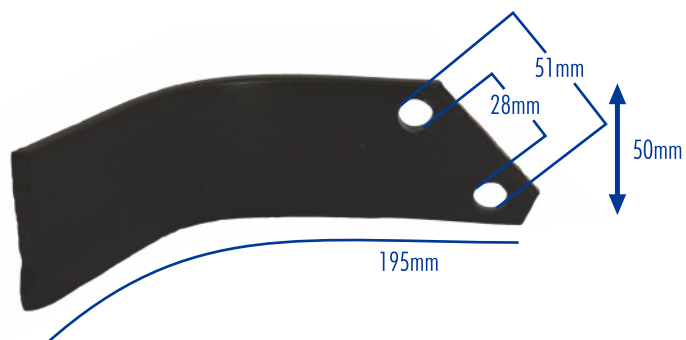

9482

FACA MOTOCULTIVADOR GOLDONI FORT CENTAURO

EAN 5604547048430

Kit de 16; furo 10mm



7514

FACA MOTOENXADA TEXAS/FERRARI/VALPADANA VM C14

EAN 5604547061163

Kit de 24; furo 10mm

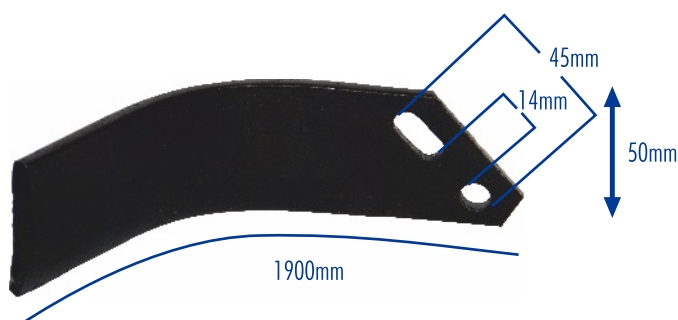

9479

FACA MOTOCULTIVADOR VALPADANA 10CV

EAN 5604547048409

Kit de 24; furo 10mm

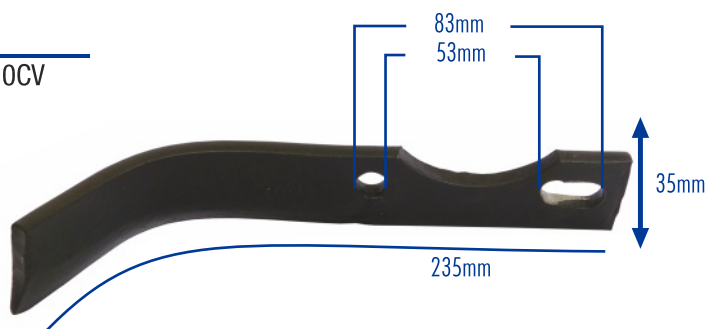

As fotos podem não corresponder em rigor ao modelo referenciado.
Peças não originais das marcas referidas.



9684

FACA MOTOENXADA HONDA furação longa
Kit de 24; furo 10mm

EAN 5604547055544

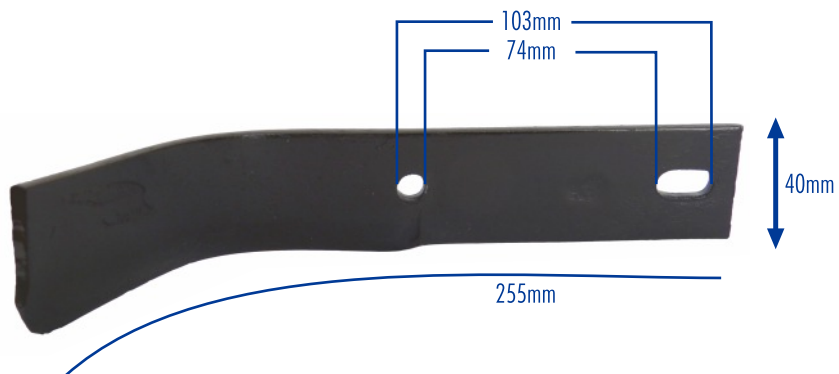

9685

FACA MOTOENXADA pequena furação curta
Kit de 24; furo 8mm

EAN 5604547055575

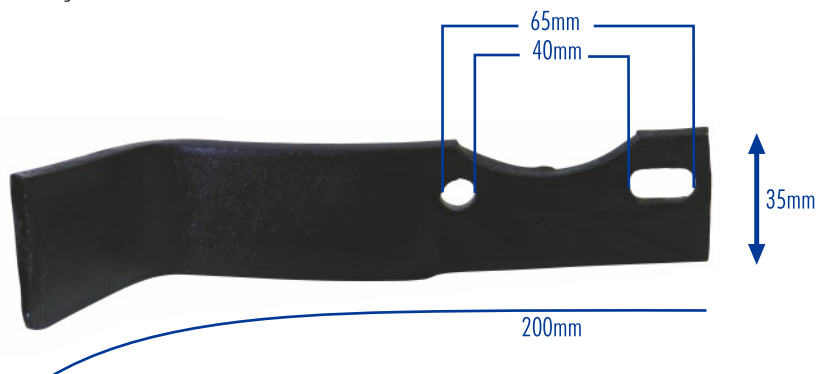

4138

FACA MOTOCULTIVADOR LIKE MINITRISS / CAVALLI
Kit de 20; furo 10mm

EAN 5604547042001

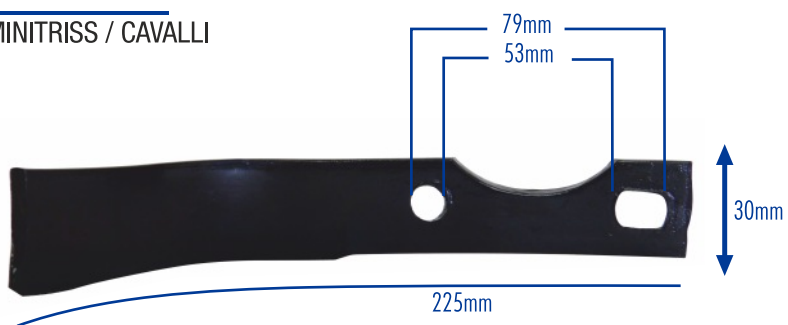

7134

FACA MOTOENXADA LIKE ML500 / ML750 / ML1000 KONTA K500

EAN 5604547066168

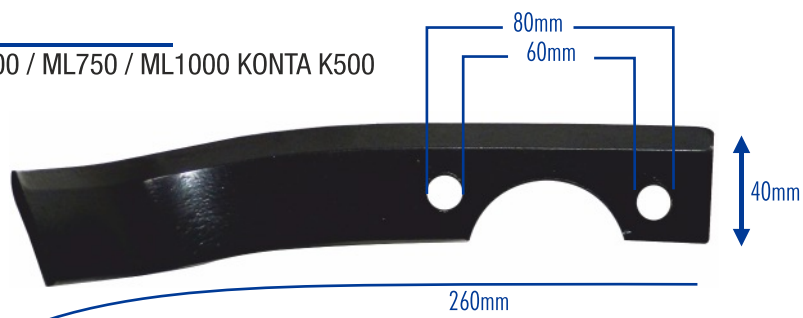

As fotos podem não corresponder em rigor ao modelo referenciado.
Peças não originais das marcas referidas.



7166

EAN 5604547064157

FACA MOTOENXADA
Fresa 25mm redondo 2020

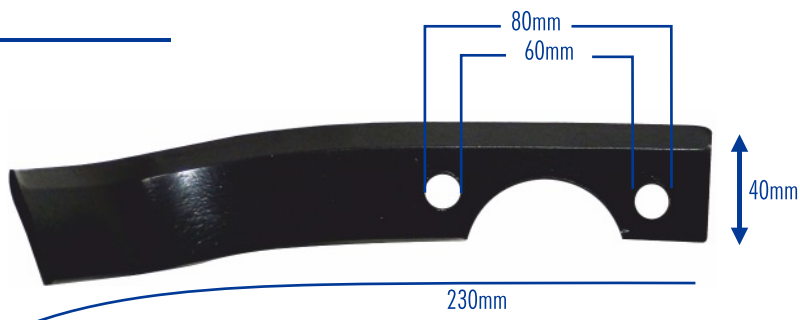

54313216

EAN 5604547023017

DISCO LATERAL LIKE 25mm (redondo Macho), Diâmetro 200mm

9767

EAN 5604547058576

DISCO LATERAL LIKE ML500 23mm (hexagonal Macho), Diâmetro 245mm

8759

EAN 5604547038059

DISCO LATERAL KIPA 32mm (hexagonal Fêmea), Diâmetro 240mm

531936

EAN 5604547017917

DISCO LATERAL LIKE 27mm (hexagonal Fêmea), Diâmetro 270mm



9485

EAN 5604547048539

DISCO LATERAL Universal Simples, Diâmetro 240mm

9486

EAN 5604547048546

DISCO LATERAL Universal Simples, Diâmetro 270mm



56230586

EAN 5604547034372

DENTE duplo de ceifeira



7185

EAN 5604547002623

LÂMINA DE CEIFEIRA



1 25

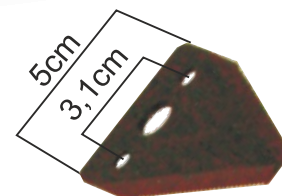

53100056

EAN 5604547034389

LÂMINA DE CEIFEIRA GRANDE



1 25

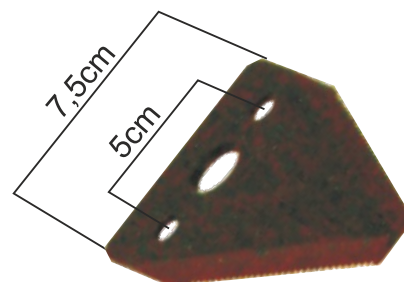



- 5123105046** PENTE CEIFEIRA LIKE 150 / FORT MICRO
EAN 5604547005303 com 15 lâminas pequenas
- 5123105076** PENTE CEIFEIRA BUSATIS LIKE 150 / FORT MICRO
EAN 5604547021648 com 15 lâminas pequenas
- 534171256** PENTE CEIFEIRA LIKE ASINO / MINIGILLET 92cm
EAN 5604547034365 com 17 lâminas pequenas
- 5123109426** PENTE CEIFEIRA LIKE / FORT 160/280
EAN 5604547017405 com 20 lâminas pequenas
- 8225** PENTE CEIFEIRA LIKE JOLY / FORT
EAN 5604547017399 com 21 lâminas pequenas
- 5LP5153016** PENTE CEIFEIRA LIKE ASINO / MINIGILLET 115cm
EAN 5604547034396 c/ banho óleo 15 lâminas grandes

- 7191** REBITE saco 100g 5,5mm x13mm (Pequeno)
EAN 5604547020948
- 9199** REBITE saco 100g 5,5mm x18mm (Grande)
EAN 5604547039698



- 4557** CAVILHA 8mm c/ freio **PACK 10**
EAN 5604547068100



- 5550** CAVILHA TIPO R 2mm **PACK 20**
EAN 5604547002425
- 5560** CAVILHA TIPO R 3mm **PACK 20**
EAN 5604547002432
- 5561** CAVILHA TIPO R 4mm **PACK 20**
EAN 5604547052901
- 5562** CAVILHA TIPO R 5mm **PACK 20**
EAN 5604547052918
- 5563** CAVILHA TIPO R 6mm **PACK 20**
EAN 5604547069206

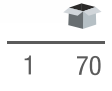

Código	A	B	C	D
5550	2	51	13	10-12
5560	3	61	18	12-16
5561	4	83	18	16-30
5562	5	108	30	20-35
5563	6	115	42	28-45

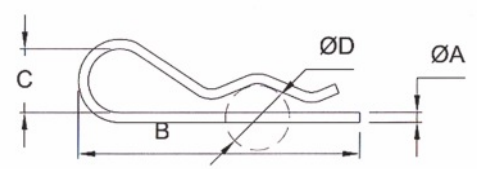

As fotos podem não corresponder em rigor ao modelo referenciado.
Peças não originais das marcas referidas.

**5510**

EAN 5604547002388

CAVILHA ELÁSTICA 45 x 8mm **PACK 20****5520**

EAN 5604547002395

CAVILHA ELÁSTICA 45 x 10mm **PACK 20****5530**

EAN 5604547002401

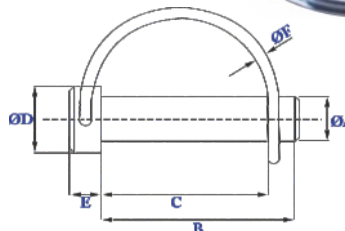
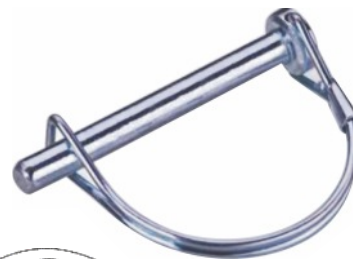
CAVILHA ELÁSTICA 65 x 8mm **PACK 20****Código****A B C D E**

5510 8 45 38 1.5 7

5520 10 45 35 1.8 8

5530 8 65 58 1.5 7

5512

EAN 5604547035119

CAVILHA ELÁSTICA 33 x 7mm **PACK 20****5509**

EAN 5604547035102

CAVILHA ELÁSTICA 33 x 8mm **PACK 20****5508**

EAN 5604547035096

CAVILHA ELÁSTICA 37 x 8mm **PACK 20****5515**

EAN 5604547024687

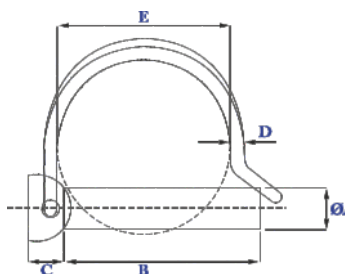
CAVILHA ELÁSTICA 33 x 10mm **PACK 20****Código****A B C D E**

5512 7 33 6 2.5 34

5509 8 33 6 2.5 34

5508 8 37 6 2.7 38

5515 10 33 6 2.5 34

5541

EAN 5604547069190

CAVILHA ELÁSTICA DE TRATOR 41 x 4.5mm **PACK 20****5513**

EAN 5604547046214

CAVILHA ELÁSTICA DE TRATOR 45 x 6mm **PACK 20****5540**

EAN 5604547002418

CAVILHA ELÁSTICA DE TRATOR 45 x 8mm **PACK 20****5507**

EAN 5604547035089

CAVILHA ELÁSTICA DE TRATOR 45 x 10mm **PACK 20****5516**

EAN 5604547052895

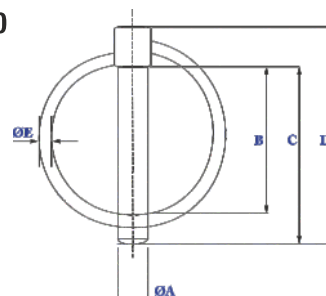
CAVILHA ELÁSTICA DE TRATOR 45 x 11mm **PACK 20****Código****A B C D E**

5541 4.5 33.0 41 51 3.0

5513 6 36.5 45 54 3.2

5540 8 36.5 45 54 3.3

5507 10 36.5 45 56 3.5

5516 11 36.5 45 56 3.5