

ACESSÓRIOS DE MOTOENXADA

Recambios de Motoazada

Mini Tiller Spare Parts

7021

EAN 5604547060951

ABRE REGOS regulável - Barra 40 x 10mm
Largura de trabalho regulável
Compatível: LIKE ML300/ ML500/ ML750/ ML1000



7005

EAN 5604547020849

ABRE REGOS N.º 2 Regulável - Barra 30 x 10mm
Largura de trabalho regulável
Furação 12mm



7015

EAN 5604547001930

ABRE REGOS N.º 2 Regulável - Barra 35 x 12mm
Largura de trabalho regulável
Furação 12mm
Adaptável: LIKE BIG/ ML500/ ML750/ ML1000



7012

EAN 5604547016521

ABRE REGOS N.º 2 - Barra 50 x 12mm
Largura de trabalho regulável
Furação 12mm

7022

EAN 5604547016774

ARRANCADOR DE BATATAS Barra 35 x 12mm
Profundidade de trabalho regulável
Compatível: LIKE BIG/ ML300/ ML500/ ML750/ ML1000
Furação 12mm

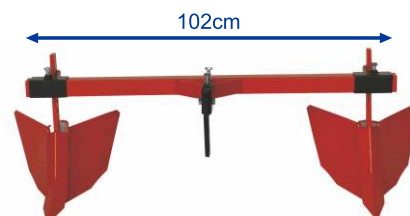

5300

EAN 5604547001947

ABRE REGOS 2 LINHAS
Largura e Profundidade de trabalho regulável



5305

EAN 5604547027237

ABRE REGOS - Aplicável à charrua
Adaptável a charruas ref. 4274 e ref. 7522
Espessura do veio: 20mm
Largura de trabalho regulável



5307

EAN 5604547027244

ARRANCADOR DE BATATAS - Aplicável à charrua
Adaptável a charruas ref. 4274 e ref. 7522
Espessura do veio: 20mm



5390

EAN 5604547002050

SACHADOR + AMONTOADOR AGRICOLA
Largura e Profundidade de trabalho regulável

5355

EAN 5604547052444

CHARRUA DESCENTRÁVEL LISA KIPA
 Profundidade de trabalho regulável,
 engate incluído 73mm altura x 16mm furo
 Adaptável: LIKE ML500/ ML750
 HONDA/ KUBOTA



7522

EAN 5604547061644

CHARRUA DESCENTRÁVEL LISA GRANDE
 Profundidade de trabalho regulável



4274

EAN 5604547066045

CHARRUA DESCENTRÁVEL VARETAS
 Profundidade de trabalho regulável



7028

EAN 5604547036161

SEMEADOR DE DISCO PARA MOTOENXADA
 Inclui: 3 discos (10, 13 e 15mm)



7594

EAN 5604547062597

SEMEADOR + ADUBADOR PARA MOTOENXADA
 Inclui: 3 discos (10, 13 e 15mm)



7595

EAN 5604547062603

SEMEADOR DE BATATAS PARA MOTOENXADA



6535

EAN 5604547027558

LANÇA para motoenxada PUBERT
Comprimento da lança: 245mm

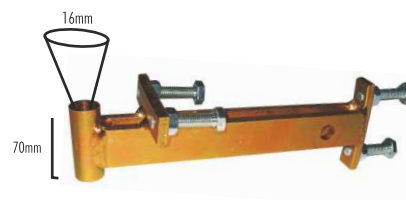

6537

EAN 5604547029309

LANÇA para motoenxada HONDA / KUBOTA
KONTA / LIKE
Comprimento da lança: 285mm



9359

EAN 5604547044593

LANÇA descentrável HONDA / KONTA
KUBOTA / LIKE
Comprimento da lança: 450mm



6370

EAN 5604547004337

ENGATE HONDA / KUBOTA / KONTA / LIKE 73 x 16mm
adaptável a:
Charrua / Abre Regos 2 linhas / Sachador / Semeador



6375

EAN 5604547027251

ENGATE YENMAR / HONDA / KUBOTA 93 x 16mm
adaptável a:
Charrua / Abre Regos 2 linhas / Sachador / Semeador



EIXOS FURAÇÃO UNIVERSAL

5501

EAN 5604547029811

EIXOS FIXOS 25mm (redondo) com 80mm comprimento PAR (2)

5502

EAN 5604547029828

EIXOS FIXOS 23mm (hexagonal) com 80mm comprimento PAR (2)

5503

EAN 5604547029835

EIXOS FIXOS 27mm (hexagonal) com 80mm comprimento PAR (2)



5506

EAN 5604547029835

EIXOS FIXOS 23mm (hexagonal) com 250mm comprimento PAR (2)
Furação Chinesa/Japonesa

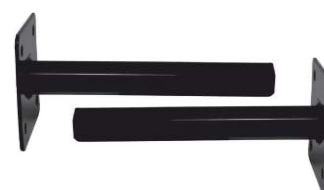

3943 DESBLOQUEIO 23mm (hexagonal) PAR (2)
 EAN 5604547070035 Furação Chinesa/Japonesa

5495 DESBLOQUEIO 25mm (Ø redondo) PAR (2)
 EAN 5604547019942 Furação Universal

5480 DESBLOQUEIO 23mm (hexagonal) PAR (2)
 EAN 5604547002326 Furação Universal

5431 DESBLOQUEIO 27mm (hexagonal) PAR (2)
 EAN 5604547056329 Furação Universal



5492 DESBLOQUEIO descentrável 23mm (hexagonal) PAR (2)
 EAN 5604547019935 Furação Universal
 Largura de trabalho mínima: 170mm
 Largura de trabalho máxima: 300mm



7032 RODA DE FERRO 340 x 80mm PAR (2)
 EAN 5604547029798

7033 RODA DE FERRO 340 x 100mm PAR (2)
 EAN 5604547029804

9515 RODA DE FERRO 400 x 100mm PAR (2)
 EAN 5604547049901

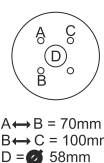

8269 RODA PNEUMÁTICA - PAR (2),
 EAN 5604547020221 c/ rasto de trator 4.00-8 ; c/ eixos fixos 23mm
 Comprimento dos eixos: 155mm

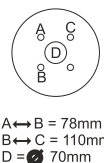

7060 RODA PNEUMÁTICA, c/ rasto de trator PAR (2)
 EAN 5604547002203 6.50-8 especial TUBLESS

7070 RODA PNEUMÁTICA,
 EAN 5604547002227 c/ rasto de trator 5.00-10 PAR (2)

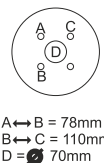

22K8 PESO DE 11 Kg Jante 8 (2 = 22Kg) PAR (2)
 EAN 5604547004061 s/ parafusos de aperto

40K10 PESO DE 20 Kg Jante 8 / Jante 10 (2 = 40Kg) PAR (2)
 EAN 5604547004054 s/ parafusos de aperto

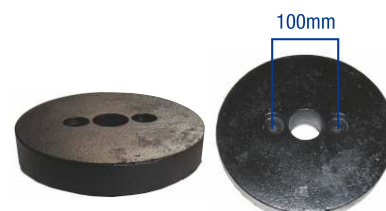

5557 CAVILHA 8mm c/ freio
EAN 5604547068100



5550 CAVILHA TIPO R 2mm
EAN 5604547002425

5560 CAVILHA TIPO R 3mm
EAN 5604547002432

5561 CAVILHA TIPO R 4mm
EAN 5604547052901

5562 CAVILHA TIPO R 5mm
EAN 5604547052918

5563 CAVILHA TIPO R 6mm
EAN 5604547069206

Código	A	B	C	D
5550	2	51	13	10-12
5560	3	61	18	12-16
5561	4	83	18	16-30
5562	5	108	30	20-35
5563	6	115	42	28-45

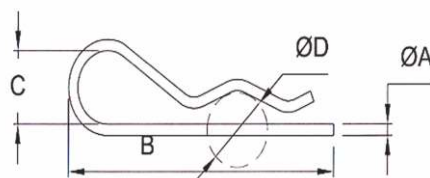

5510 CAVILHA ELÁSTICA 45 x 8mm
EAN 5604547002388

5520 CAVILHA ELÁSTICA 45 x 10mm
EAN 5604547002395

5530 CAVILHA ELÁSTICA 65 x 8mm
EAN 5604547002401

Código	A	B	C	D	E
5510	8	45	38	1.5	7
5520	10	45	35	1.8	8
5530	8	65	58	1.5	7

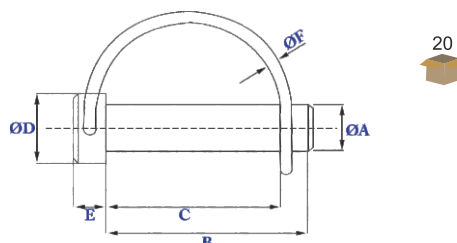

5512 CAVILHA ELÁSTICA 33 x 7mm
EAN 5604547035119

5509 CAVILHA ELÁSTICA 33 x 8mm
EAN 5604547035102

5508 CAVILHA ELÁSTICA 37 x 8mm
EAN 5604547035096

5515 CAVILHA ELÁSTICA 33 x 10mm
EAN 5604547024687

Código	A	B	C	D	E
5512	7	33	6	2.5	34
5509	8	33	6	2.5	34
5508	8	37	6	2.7	38
5515	10	33	6	2.5	34

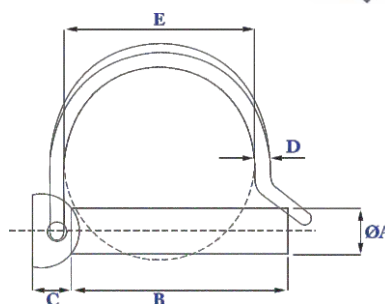

- 5541** CAVILHA ELÁSTICA DE TRATOR 41 x 4.5mm
EAN 5604547069190
- 5513** CAVILHA ELÁSTICA DE TRATOR 45 x 6mm
EAN 5604547046214
- 5540** CAVILHA ELÁSTICA DE TRATOR 45 x 8mm
EAN 5604547002418
- 5507** CAVILHA ELÁSTICA DE TRATOR 45 x 10mm
EAN 5604547035089
- 5516** CAVILHA ELÁSTICA DE TRATOR 45 x 11mm
EAN 5604547052895

Código	A	B	C	D	E
5541	4.5	33.0	41	51	3.0
5513	6	36.5	45	54	3.2
5540	8	36.5	45	54	3.3
5507	10	36.5	45	56	3.5
5516	11	36.5	45	56	3.5



20

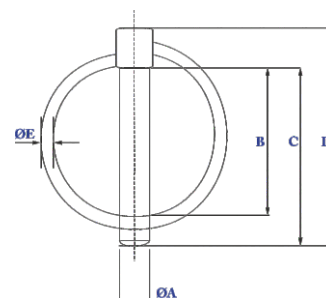

- 7185** LÂMINA DE CEIFEIRA pequena / ML850
EAN 5604547002623

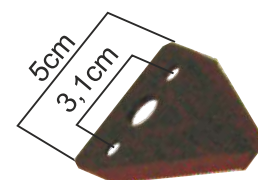

25

- 7191** REBITE saco 100g 5,5mm x13mm (Pequeno)
EAN 5604547020948
- 9199** REBITE saco 100g 5,5mm x18mm (Grande)
EAN 5604547039698



- 8751** PENTE CEIFEIRA LIKE ML850
EAN 5604547076587
- 5123109426** PENTE CEIFEIRA LIKE / FORT 160/280 com 20 lâminas pequenas
EAN 5604547017405
- 8225** PENTE CEIFEIRA LIKE JOLY / FORT com 21 lâminas pequenas
EAN 5604547017399
- 5LP5153016** PENTE CEIFEIRA LIKE ASINO / MINIGILLET 115cm c/ banho óleo 15 lâminas grandes
EAN 5604547034396



- 8110** TUBO HEXAGONAL 22mmx30mm
EAN 5604547019393
- 8108** TUBO HEXAGONAL 23mmx32mm
EAN 5604547002876
- 9639** TUBO HEXAGONAL 26mmx35mm
EAN 5604547054363
- 8112** TUBO HEXAGONAL 27mmx35mm
EAN 5604547019409



Metro

7160

EAN 5604547002593

FACA MOTOENXADA SAFARY / GIRA
DAKAR / KONTA WM500
Kit de 24; furo 8mm

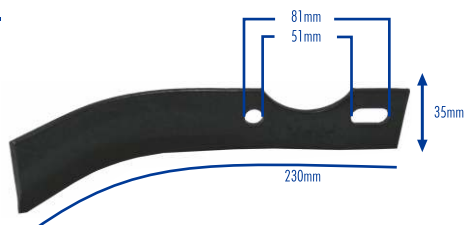

7168

EAN 5604547032484

FACA MOTOENXADA HELICOIDAL SAFARY / GIRA
DAKAR / KONTA WM500
Kit de 24; furo 8mm

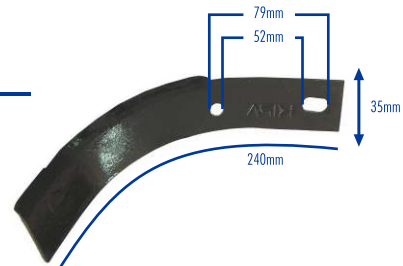

7165

EAN 5604547002609

FACA MOTOENXADA BOSS / BIG;
Kit de 24; furo 10mm

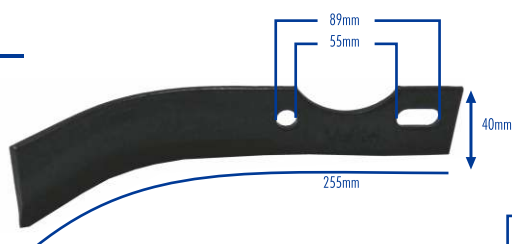

7170

EAN 5604547002616

FACA MOTOENXADA FAMOSA / BIG;
Kit de 24; furo 10mm

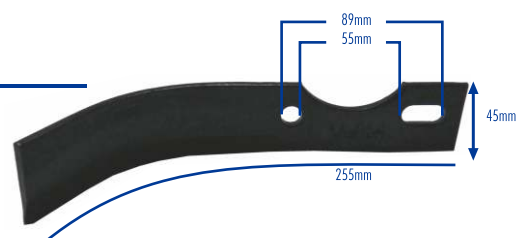

9480

EAN 5604547048416

FACA MOTOENXADA FORT MINI TIGRE
Kit de 24; furo 8mm

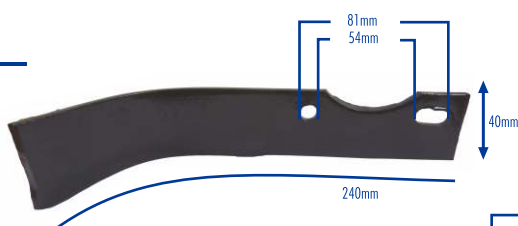

9476

EAN 5604547048379

FACA MOTOENXADA HONDA furação larga
Kit de 24; furo 8mm

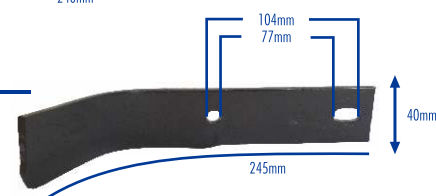

9477

EAN 5604547048386

FACA MOTOENXADA FORT MINI TIGROTO
Kit de 24; furo 10mm

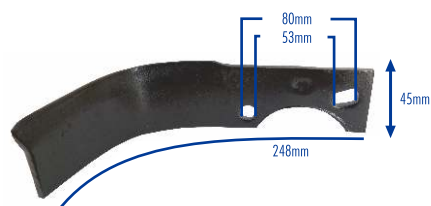

9481

EAN 5604547048423

FACA MOTOCULTIVADOR GOLDONI FORT
Kit de 20; furo 10mm

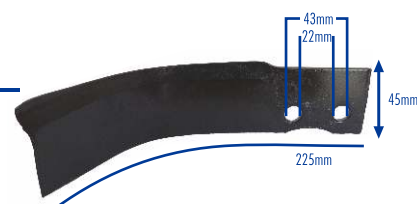

9483

EAN 5604547048447

FACA MOTOCULTIVADOR GRILO/GOLDONI
Kit de 24; furo 10mm

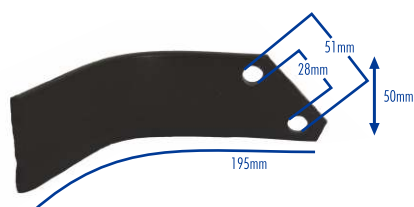

9482 FACA MOTOCULTIVADOR
 EAN 5604547048430 GOLDONI FORT CENTAURO
 Kit de 16; furo 10mm

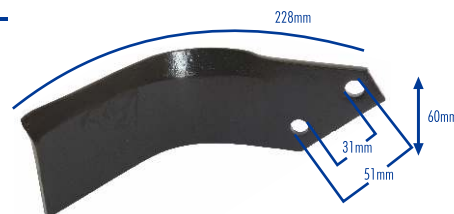

7514 FACA MOTOENXADA
 EAN 5604547061163 TEXAS/FERRARI/VALPADANA VM C14
 Kit de 24; furo 10mm

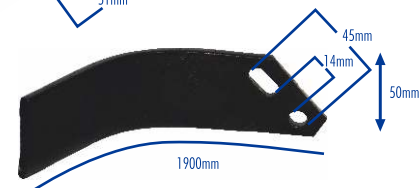

9479 FACA MOTOCULTIVADOR VALPADANA 10CV
 EAN 5604547048409 Kit de 24; furo 10mm

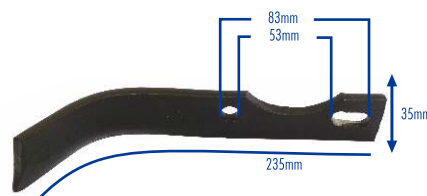

9684 FACA MOTOENXADA HONDA
 EAN 5604547055544 furação longa
 Kit de 24; furo 10mm

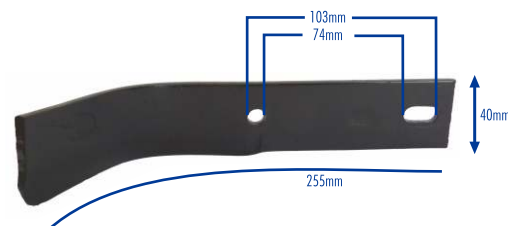

9685 FACA MOTOENXADA
 EAN 5604547055575 pequena furação curta
 Kit de 24; furo 8mm

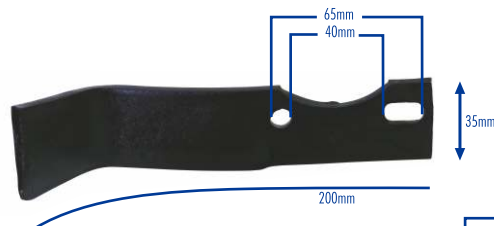

4138 FACA MOTOCULTIVADOR
 EAN 5604547042001 LIKE MINITRISS / CAVALLI
 Kit de 20; furo 10mm

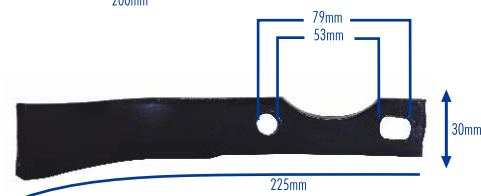

7134 FACA MOTOENXADA
 EAN 5604547066168 LIKE ML500 / ML750 / ML1000 KONTA K500
 Kit de 24; furo 10mm

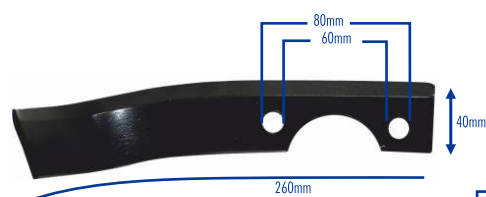

7166 FACA MOTOENXADA
 EAN 5604547064157 Fresa 25mm redondo 2020
 Kit de 24; furo 10mm

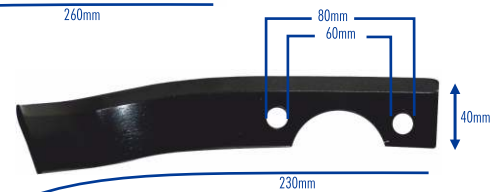

7133 FACA MOTOCULTIVADOR
 EAN 5604547066724 LIKE ML900
 Kit de 20; furo 10mm

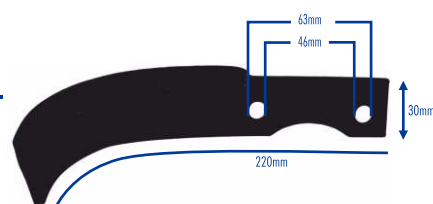

7137 FACA MOTOCULTIVADOR
 EAN 5604547073319 LIKE ML800
 Kit de 16; furo 10mm

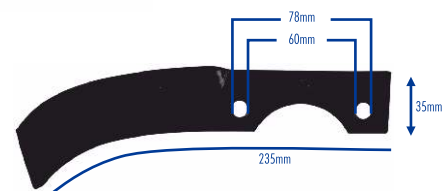

54313216

EAN 5604547023017

DISCO LATERAL LIKE 25mm (redondo Macho), Diâmetro 200mm

9767

EAN 5604547058576

DISCO LATERAL LIKE ML500 23mm (hexagonal Macho), Diâmetro 245mm

8759

EAN 5604547038059

DISCO LATERAL KIPA 32mm (hexagonal Fêmea), Diâmetro 240mm

531936

EAN 5604547017917

DISCO LATERAL LIKE 27mm (hexagonal Fêmea), Diâmetro 270mm



9485

EAN 5604547048539

DISCO LATERAL Universal Simples, Diâmetro 240mm

9486

EAN 5604547048546

DISCO LATERAL Universal Simples, Diâmetro 270mm

8412

EAN 5604547024083

FRESA KIPA 25mm (Ø redondo) Par (2)
 Distância da extremidade até ao centro do furo: 20mm
 Diâmetro do furo: 10mm
**MOTOENXADAS DE CORREIAS
 FRANCESAS E ITALIANAS**

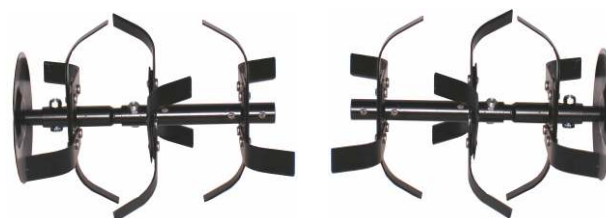

4000

EAN 5604547058200

FRESA LIKE 23mm (hexagonal) Par (2)
 Distância da extremidade até ao centro do furo: 55mm
 Diâmetro do furo: 8mm
 Diâmetro Guarda Pó: 65mm
MOTOENXADA ML500/ML750



4007

EAN 5604547068865

FRESA LIKE 23mm (hexagonal) Par (2)
 Distância da extremidade até ao centro do furo: 55mm
 Diâmetro do furo: 8mm / Sem guarda pó
MOTOENXADA LIKE ML 1000



6478

EAN 5604547018839

FRESA LIKE 27mm (hexagonal) Par (2)
 Distância da extremidade até ao centro do furo: 50mm
 Diâmetro do furo: 8mm
MOTOENXADA LIKE BOSS/BIG



7083

EAN 5604547032705

RODA DE TRANSPORTE Vulgar (par)

Diâmetro da Roda: 420mm**Distância entre furos: 104mm****8417**

EAN 5604547025271

RODA PNEU 3.50-8 CARRINHO de PULVERIZAÇÃO
c/ ROLAMENTOS**PNEU: 4PR****Diâmetro do Furo: 20mm****Comprimento do Furo: 70mm**

5

**9510**

EAN 5604547049840

ROLAMENTO RODA CARRINHO 3.50-8

**9641**

EAN 5604547054509

RODA POLIURETANO 3.00-4 c/ CASQUILHO E ROLAMENTO
DE AGULHAS**Cor: Preta****Diâmetro do Furo: 16mm****Comprimento do Furo: 75mm**

10

**8418**

EAN 5604547052390

RODA PNEU 3.00-4 (jante metálica) c/ ROLAMENTO

Diâmetro do Furo: 20mm**Comprimento do Furo: 70mm**

10

**9306**

EAN 5604547047754

RODA POLIURETANO 3.00-4 c/ CASQUILHO E ROLAMENTO
DE AGULHAS**Cor: Amarela****Diâmetro do Furo: 20mm****Comprimento do Furo: 75mm**

10

**9217**

EAN 5604547040007

RODA PNEU 3.50-8 (CARRO DE MÃO)

PNEU: 4PR**Diâmetro do Eixo: 20mm****Comprimento do Eixo: 245mm**

9393

EAN 5604547045903

RODA POLIURETANO 3.50-8 (CARRO DE MÃO)

Cor: Amarela

Diâmetro do Eixo: 20mm

Comprimento do Eixo: 245mm



9366

EAN 5604547044715

RODA CARRO MOTOR REGA / BETONEIRA

Diâmetro da Roda: 250mm

Diâmetro do Furo: 20mm



7926

EAN 5604547037151

PNEU + CÂMARA - 3.00-4 4PR **Válvula Curva**

10



9394

EAN 5604547045910

PNEU + CÂMARA - 3.50-8 6PR

10



7105

EAN 5604547002456

PNEU + CÂMARA - Rasto de trator - 4.00-8 4PR

7120

EAN 5604547002487

PNEU + CÂMARA - Rasto de trator - 5.00-10 6PR



7701

EAN 5604547037120

CÂMARA DE AR - 3.00-4 (válvula curva)

7817

EAN 5604547063648

CÂMARA DE AR - 3.50-6

7707

EAN 5604547037137

CÂMARA DE AR - 3.50-8

7700

EAN 5604547005709

CÂMARA DE AR - 4.00-8

7822

EAN 5604547063679

CÂMARA DE AR - 16.650-8

7710

EAN 5604547005723

CÂMARA DE AR - 4.00 / 4.50-10

7824

EAN 5604547063693

CÂMARA DE AR - 5.00/6.50/80-12

